

PT502

RCVR/EXC
KTR-953

030-01176-0000 CONNECTOR (REF)
030-01157-0011 SOCKET (REF)
030-02351-0004 HOOD & LEVER (REF)

AGC
-26VDC
A3A
ON/OFF
+12VDC
+5VDC
LOGIC GND
POWER ON RESET
CLARIFIR ON/OFF
OVEN & SYN RDY
RCVR BB0
RCVR BB1
RCVR BB2
RCVR AM
RCVR XMT
RCVR TUNE
RCVR AUDIO (HI)
RCVR AUDIO (LO)
MIC AUDIO (HI)
MIC AUDIO (LO)
SQUELCH
VOL & SOUL REF
VOL VAR
SYN STROBE
SYN DATA
SYN CLK
CHASIS GND
28VDC
28VDC
POWER GND
POWER GND
ALC
ALC REF-PWR OFF

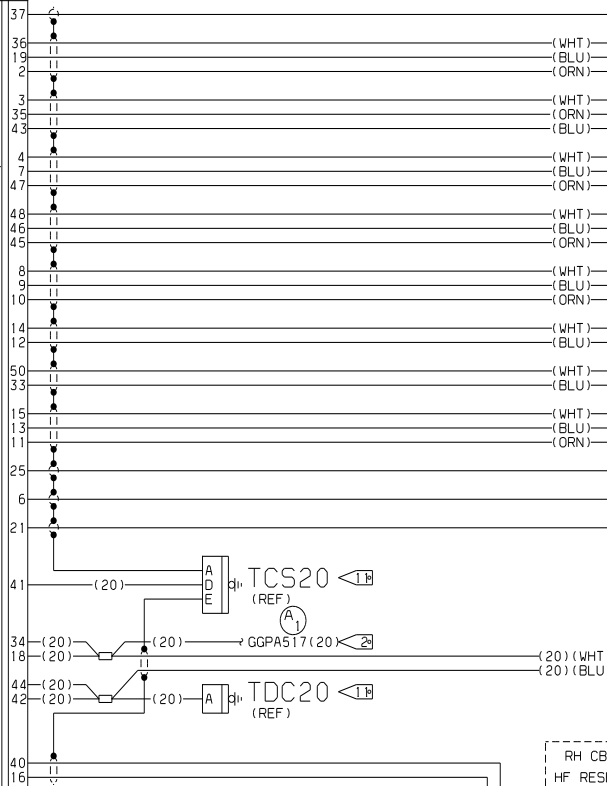

PT504

PA/CPLR
KAC-952

030-02364-0000 CONNECTOR (REF)
030-01080-0000 20AWG SOCKETS (REF)
030-01085-0000 16AWG SOCKETS (REF)

PT1002
PT1004
030-00005-0001 COAX CONN (REF)
PT1042
249GQH-204 (REF)
PT1043
POWER OFF SENSE
ALC
PA BB0
PA BB1
PA BB2
CPLR BYPASS
PA TUNE
PA XMT
CPLR RDY
CPLR FAULT
PA LOGIC REF
DC GND
DC GND
28VDC
28VDC

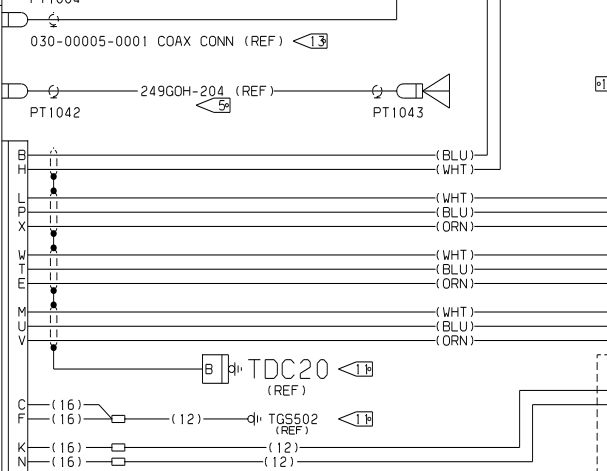

2
 6

030-01176-0000 CONNECTOR (REF)
030-01157-0011 SOCKET (REF)
030-01188-0000 POLAR SOCKET (REF)
030-02351-0004 HOOD & LEVER (REF)

PT506

ADAPTER
KA 594

AGC
-26VDC
A3A 0/9
ON/OFF
+12VDC
+5VDC
LOGIC GND
LSB DISABLE
POWER ON RESET
CLARIFY ON/OFF
OVEN & SYN RDY
RX BB0
RX BB1
RX BB2
RX AM
RX XMT
RX TUNE
AUDIO OUT (HI)
AUDIO OUT (LO)
MIC AUDIO (HI)
MIC AUDIO (LO)
SQUELCH
VOL & SQUELCH
VOL VAR
SYN STROBE
SYN DATA
SYN CLOCK
POLARIZING SOCKET
+28VDC
GND
CHASSIS GND
PA BB0
PA BB1
PA BB2
CPLR BYPASS
PA TUNE
PA XMT
CPLR RDY
CPLR FAULT
PA LOGIC (REF)

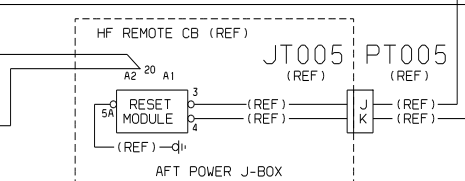
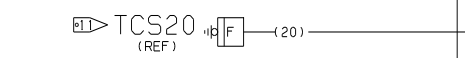
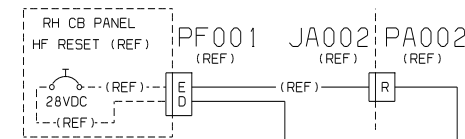

REVISONS			
SHEET	REV	DESCRIPTION	DATE APPROVED
1	A	BY REVISION:	03/22/02 RS
1	1	1)GGPA517 WAS GGPA513. 2) CHANGED FLAG NOTE 17, WAS: "S3070-10, CESSNA CODE FOR VENDOR P/N LMD4003P PIN MODULE AND LMD4022-36LJ PIN CONTACT. PLYE NATIONAL CORP., CHICAGO, IL."	
2	2	3)REMOVED S3070-10 ADDED LMD-4003-P CONNECTOR ADDED LMD-4022-36LJ CONTACT (16) EFF: EC565271	

NOTES:

- SEE SHEET 1.
- SEE SHEET 2.
- TYCO ELECTRONICS, MIDDLETOWN, PA.
- AN ASTERISK PRECEDING A LETTER INDICATES LOWER CASE.
- ELECTRONIC CABLE SPECIALISTS (ECS), FRANKLIN, WI.
- ALLIED SIGNAL, OLATHE, KS.
- ITT CANNON, SANTA ANA, CA.
- MISC HARDWARE:
 - M81824/1-1 SPLICE
 - M81824/1-2 SPLICE
 - D436-38 SPLICE
 - MS25036-102 TERMINAL
 - MS25036-149 TERMINAL
 - MS25036-112 TERMINAL
 - S2974N2 SOLDER SLEEVE
 - S2974N3 SOLDER SLEEVE
- ALL WIRES TO BE PER MIL-W-81044/12, 22 AWG, EXCEPT AS NOTED.
- SINGLE CONDUCTOR SHIELDED WIRE PER M27500-**ML1T08
TWO CONDUCTOR SHIELDED WIRE PER M27500-**ML2T08
THREE CONDUCTOR SHIELDED WIRE PER M27500-**ML3T08
TWO CONDUCTOR TWISTED WIRE PER M27500-**ML2U00
** INDICATES 22 AWG, EXCEPT AS NOTED.
- REFER TO 8654500 FOR LIGHTING AND GROUND BLOCK/STUD LOCATIONS.
- AFFIX CM2987-5 ID TAG NEAR PLUG.
- PART OF A/S INSTL KIT KPN 050-01847-0001
- PART OF A/S INSTL KIT KPN 050-01848-0001
- PART OF A/S INSTL KIT KPN 050-01986-0001
- PART OF A/S INSTL KIT KPN 050-01993-0001
- PLYE NATIONAL CORP., CHICAGO, IL.
- PINS 4, 5, AND 6 OF JF558 ONLY USED WITH OPTIONAL AVTECH AUDIO.
- THIS DRAWING FILED IN CCD.

DATE 02/01/2002	CESSNA AIRCRAFT COMPANY
DRAWN RUSSELL SHARP	AIRCRAFT DIVISION
GROUP	P.O. BOX 7704
CHECK	WICHITA, KANSAS 67277
SECT	CABLE ASSY
PROJ	KHF-950 HF COMM
M. E.	
OTHER	
FABRICATE PER CSAM005	SIZE F30M NO.
PROCESS PER XXXXXXXXXXXXX	DWG NO.
WIRE TERMINATION PER_CS2716	F71379
	8610112
	SCALE: SCL PART: 8610101 SHEET 1 OF 2

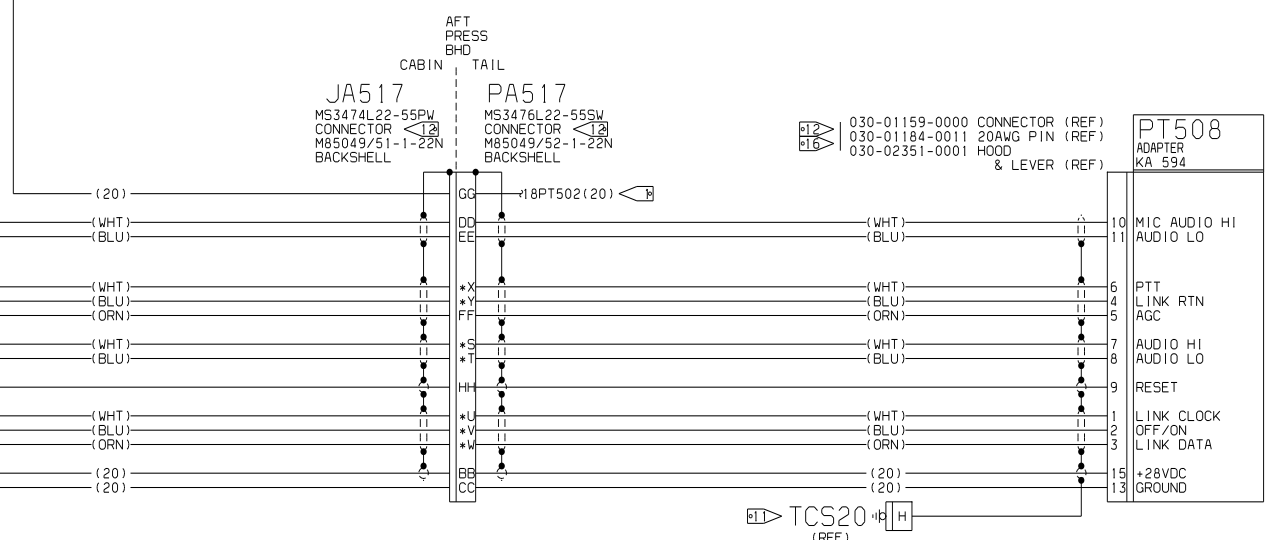
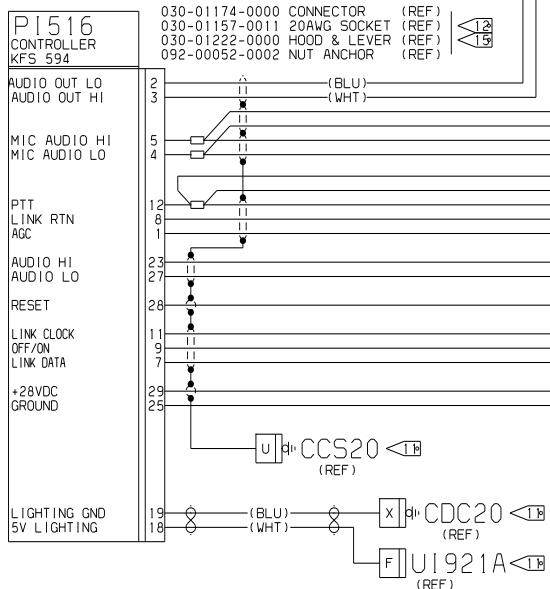
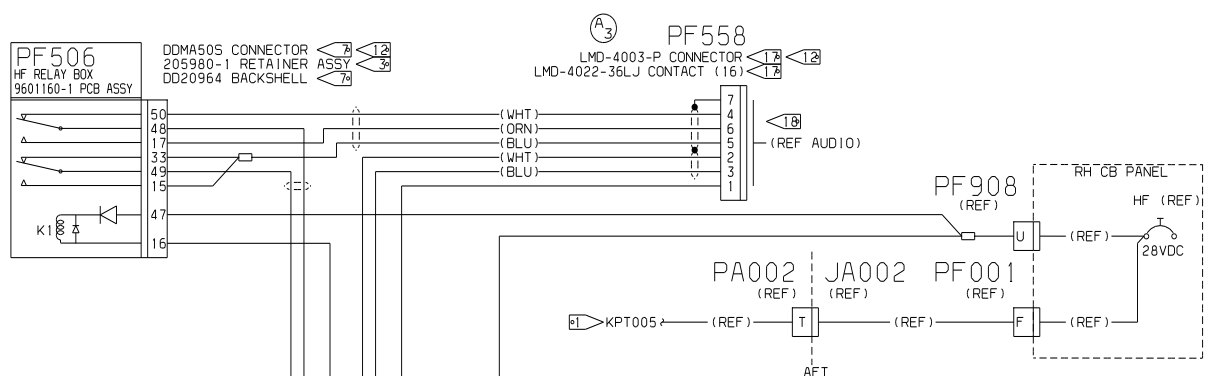

DATE	02/01/2002	CESSNA AIRCRAFT COMPANY
DRAWN	RUSSELL SHARP	AIRCRAFT DIVISION
GROUP		P.O. BOX 7704
CHECK		WICHITA, KANSAS 67277
SECT		
PROJ		
M. E.		
OTHER		
FABRICATE PER CSAM005		SIZE F50H NO.
PROCESS PER XXXXXXXXXXXXX		DWG NO.
WIRE TERMINATION PER CS2716		F71379
SCALE: SCL		8610112
		SHEET 2 OF 2

8610112
 EC 565271